

Performance

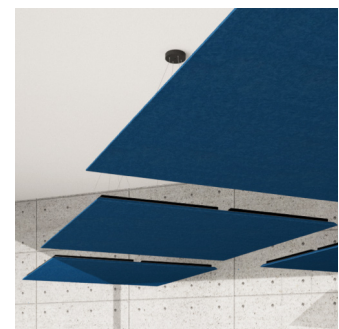

Technical Information

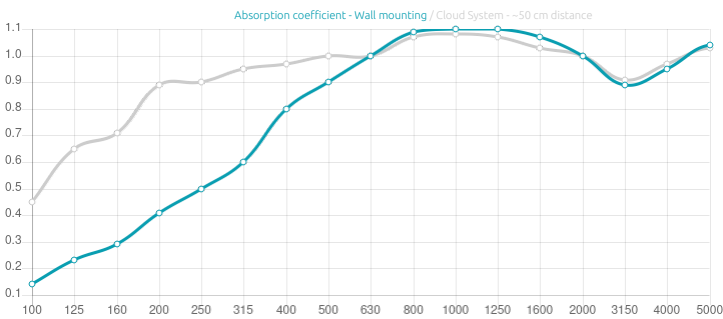
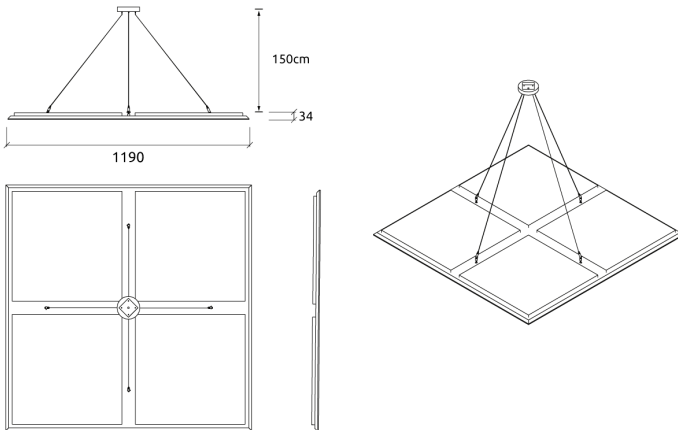

Features

Absorption Range: 350 Hz to 8000 Hz  
Acoustic Class: B | (aw) = 0,85

This product is available in the following Fire Rates:  
FG | Furniture Grade  
FR | Fire Rated  
FR | Fire Rated & COVID-19 Safe

PRODUCT COMPOSITION:

Azores | Suede Fabric Finishes (FG)  
- Suede Acoustic Fabric  
- Marine grade plywood structural frame\*  
- Sound PET absorption layer

Azores | Felted Fabric Finishes (FR)  
- Felted Acoustic Fabric  
- Fire retardant HMDF structural frame\*  
- Sound PET acoustic core - Euro Class B

Azores | Twill Fabric Finish (FR & COVID-19 Safe)  
- Twill Acoustic Fabric - COVID-19 Safe  
- Fire retardant HMDF structural frame\*  
- Sound PET absorption layer

The PET core is a material made entirely from recycled PET plastic, that undergoes an environmentally-friendly transformation process into the non-woven acoustic core we use in this panel.

Installation:  
- Single Point Fixing System (Cloud SP)\*\*

Azores is suspended with an easily adjustable cable system, that allows to hang the panel up to 1,5m from the ceiling.

\*Equipped with four M6 Screw Thread receiver  
\*\*Ceiling suspension kit included

Notice:Compatible with Grippl Angel TM Hanger

Dimensions:

FG - SF | 1190x1190x34mm | 5.0 Kg  
FR - TF | 1190x1190x34mm | 5.3 Kg  
FR - WF | 1190x1190x34mm | 5.3 Kg



Azores Double SQR cloud is a quality fabric covered panel, designed to improve the acoustics of large open environments. Many spaces such as open offices or restaurants not only have limited wall space, but also benefit largely from treating ceiling reflections. Azores cloud has exceptional performance, especially when spaced from the ceiling, and is available in a large range of fabric finishes.

**Product finishes**

**(FG - SF) Suede Fabric Finishes**



**(FR - TF) Twill Fabric Finishes | COVID-19 Safe (cleanable)**

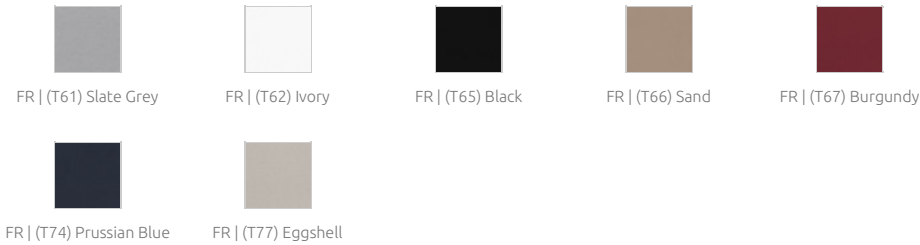

**(FR - WF) Weave Fabric Finishes**

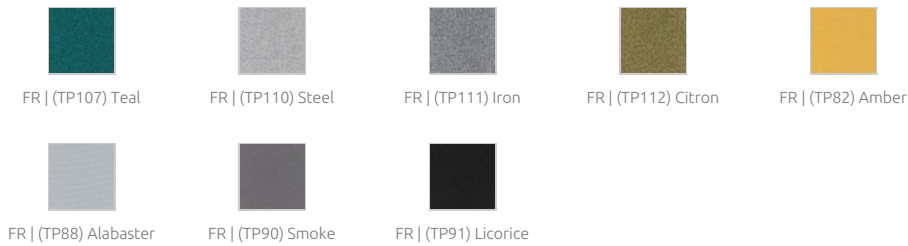

**(FR - TT) Felted Fabric Finishes**

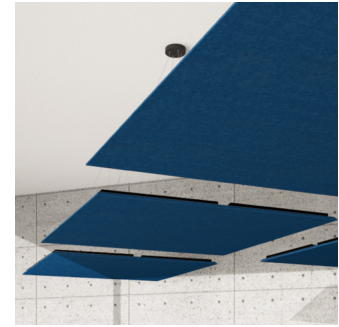
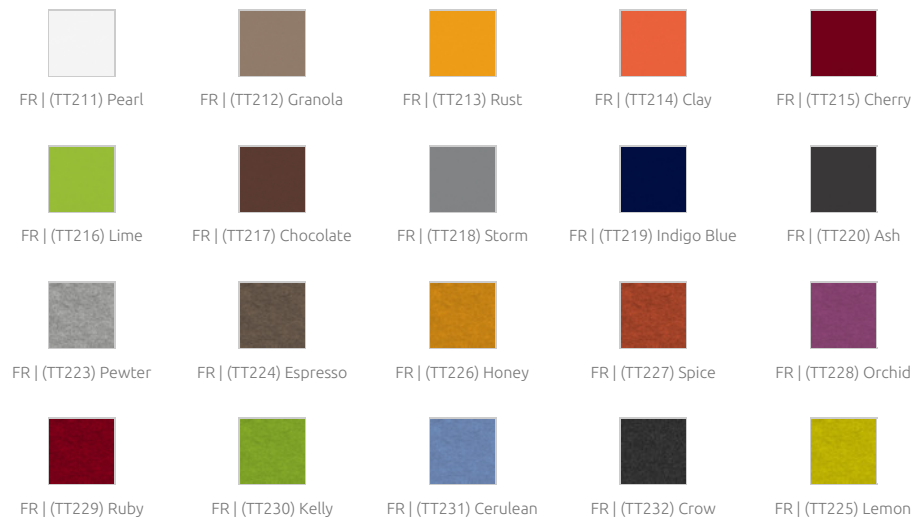

**Purpose**

- RT reduction
- Flutter echo control
- Reducing excessive reverberation
- Improving speech intelligibility

**Recommended for**

- Office meeting room
- Conference room
- Open workspace
- Restaurants